

# MTN-264-27

Part Number	Description	Type	Package Cooled	Attachment Method	Length	Width	Height Off Base (Height of Fin)	Thermal Resistance @ Forced Air Flow	Material	Material Finish
MTN-264-55	HEATSINK w/ Two Clips for TO-247 TO-264	Top Mount	TO-247 and TO-264	Clip and PC Pin	1.06" (27mm)	1.740" (44.3mm)	1.56" (39.5mm)	5.5°C/W @ 18 Watts	Aluminum	Black Anodized



Wakefield-Vette's *Mountain Series Heat Sinks* are high performance, low cost, configurable, scalable and compact with a matrix clip system for TO220, TO-247, TO-264 and other standard packages. This type powerful heat sink provides easiest assembly, largest surface areas, smallest space occupation and all-in-one solution. The power dissipations can be easily increased simply by extending the fin height on each side of the heat sink, while keeping the heat sink height and PCB layout the same. It is the ideal type of heat sink for high power density and small size (1U or 2U) electronic packaging with forced convection cooling.

### FEATURES AND BENEFITS

Minimum assembly cost and labor Spring Clips make the mounting holes and fasteners obsolete in assembly operations & reduce costs.

Maximum Thermal Transfer Maximum surface area per unit volume, efficient cooling fins & consistent mounting force reduces thermal resistance

Maximum Repeatability Constant spring force over repeated assembly/disassembly

Maximum Reliability Resilient spring action locks electronic component in place. Fewer parts in assembly and no fasteners and washers required. Prevent short circuit by eliminating metal particles generated from hardware or thread tapping

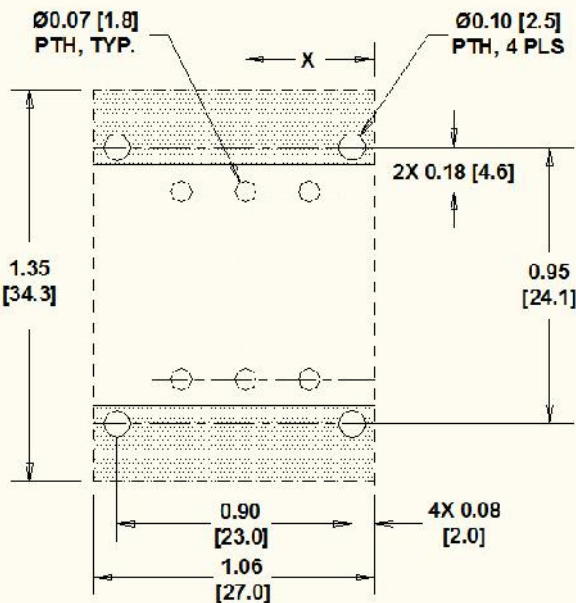
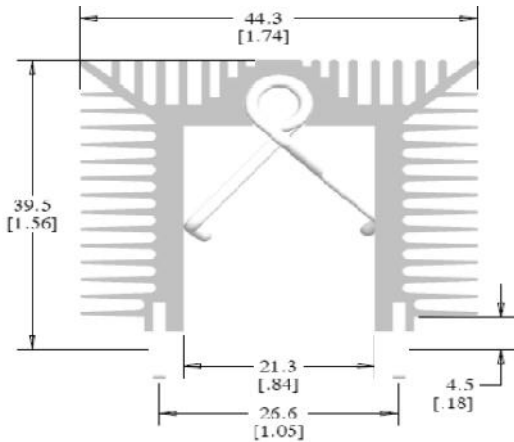

X IS USER'S DEFINED PARAMETERS

### Thermal Resistance

