

1-Watt SMD 6mm (120° Viewing Angle)

OVSPxBCR4 Series

- Robust energy-efficient design with long operating life
- Low thermal resistance
- High luminous intensity
- Optional optics to suit application

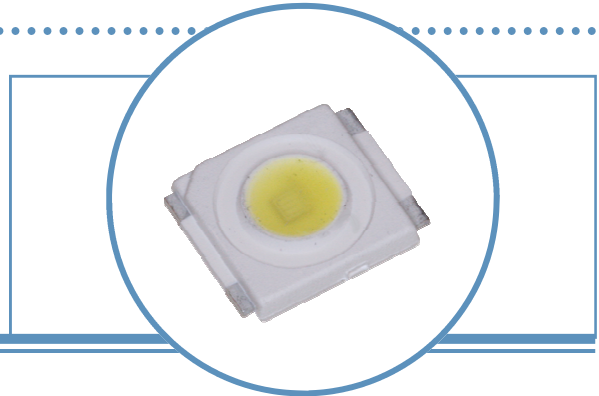

The **OVSPxBCR4 Series** is an energy-efficient packaged LED source that offers high luminance, and a long operating lifespan. These devices offer a 120° viewing angle and an ultra-low profile (1.5mm) making them highly suitable for conventional lighting and specialized applications. Optional optics are offered to suit application. Please contact OPTEK for more information.

Applications

- Automotive exterior and interior lighting
- Architectural indoor and outdoor lighting
- General lighting
- Electronic signs and signals

Part Number	Viewing Angle	Material	Emitted Color	Typical Luminous Flux (lm)	Lens Color
OVSPBBCR4	120°	InGaN	Blue	20	Water Clear
OVSPGBCR4		InGaN	Green	54	Water Clear
OVSPRBCR4		AllnGaP	Red	42	Water Clear
OVSPYBCR4		AllnGaP	Yellow	34	Water Clear
OVSPW1BCR4		InGaN	White	90	Water Clear

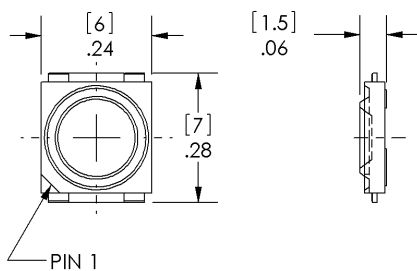

DIMENSIONS ARE IN INCHES [MM]
GENERAL TOLERANCES ±.004 [0.10]

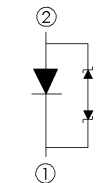
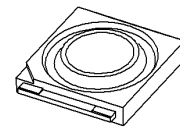
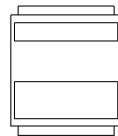

BLUE, GREEN

PIN 1	PIN 2
CATHODE	ANODE

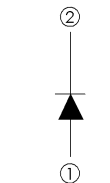

RED, YELLOW

PIN 1	PIN 2
ANODE	CATHODE

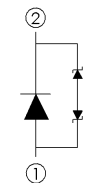

WHITE

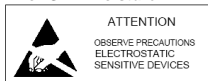

DO NOT LOOK DIRECTLY AT LED WITH UNSHIELDED EYES OR DAMAGE TO RETINA MAY OCCUR.

OPTEK reserves the right to make changes at any time in order to improve design and to supply the best product possible.

Absolute Maximum Ratings $T_A = 25^\circ\text{C}$

	Red, Yellow	Green, Blue	White
DC Forward Current	400mA	350mA	350mA
Peak Pulsed Forward Current ¹	500mA	1000mA	1000mA
Reverse Voltage	12V	Not designed for reverse bias	
Junction Temperature ²	125°C	120°C	150°C
Power Dissipation	1200mW		
Storage and Operating Temperature	-40° ~ +100 °C		
MSL Level (IPC/JEDEC J-STD-020C)	2a / 672 Hrs		
ESD Threshold (HBM)	Class 2		

Notes:

1. Pulse width $t_p \leq 10\mu\text{s}$, Duty cycle = 0.1
2. Thermal conductivity = 20K/W for red, yellow, green, blue; and 18K/W for white

Optical and Electrical Characteristics—Red, Yellow ($I_F = 400\text{ mA}$, $T_A = 25^\circ\text{C}$)

SYMBOL	PARAMETER	MIN	TYP	MAX	UNITS	
V_F	Forward Voltage	2.2	2.5	2.8	V	
Φ	Luminous Flux	Red	33	42	54	lm
		Yellow	27	34	42	lm
λ_D	Dominant Wavelength	Red	620	625	630	nm
		Yellow	585	591	597	nm
I_R	Reverse Current	----	100	----	μA	
$2\theta_{1/2}$	50% Power Angle	----	120	----	deg	

Optical and Electrical Characteristics—Blue, Green ($I_F = 350\text{ mA}$, $T_A = 25^\circ\text{C}$)

SYMBOL	PARAMETER	MIN	TYP	MAX	UNITS	
V_F	Forward Voltage	----	3.6	4.0	V	
Φ	Luminous Flux	Blue	13	20	27	lm
		Green	38	54	79	lm
λ_D	Dominant Wavelength	Blue	460	470	475	nm
		Green	520	530	535	nm
$2\theta_{1/2}$	50% Power Angle	----	120	----	deg	

Optical and Electrical Characteristics—White ($I_F = 350\text{ mA}$, $T_A = 25^\circ\text{C}$)

SYMBOL	PARAMETER	MIN	TYP	MAX	UNITS
V_F	Forward Voltage	3.0	3.5	4.0	V
Φ	Luminous Flux	67	90	113	lm
$2\theta_{1/2}$	50% Power Angle	----	120	----	deg

OPTEK reserves the right to make changes at any time in order to improve design and to supply the best product possible.

1-Watt SMD 6mm OVSPxBCR4 Series

Standard Bins

LEDs are sorted to the luminous flux (Φ) and the dominant wavelength (nm) bins shown. Each reel consists of a single intensity bin and a single color bin. Orders are filled utilizing all of the intensity bins or color bins listed in the following tables. Optek will not accept orders for single intensity bins or single color bins.

Luminous Flux (Φ) @ 350mA (lm)

Blue: OVSPBBCR4		
IV Code	Min (lm)	Max (lm)
Z1	13	16
Z2	16	21
AA	21	27
Green: OVSPGBCR4		
IV Code	Min (lm)	Max (lm)
AD	38	48
AE	48	60
AF	60	79

Dominant Wavelength (nm)

Blue: OVSPBBCR4		
nm Code	Min (nm)	Max (nm)
AO	460	465
A	465	470
B	470	476
Green: OVSPGBCR4		
nm Code	Min (nm)	Max (nm)
AO	520	525
A	525	530
B	530	535

Luminous Intensity (I_v) @ 400mA

Red: OVSPRBCR4		
IV Code	Min (lm)	Max (lm)
AC	33	42
AD	42	54
Yellow: OVSPYBCR4		
IV Code	Min (lm)	Max (lm)
AB	27	34
AC	34	42

Dominant Wavelength (nm)

Red: OVSPRBCR4		
nm Code	Min (nm)	Max (nm)
Full	620	630
Yellow: OVSPYBCR4		
nm Code	Min (nm)	Max (nm)
A	585	588
B	588	591
C	591	594
D	594	597

Beam Angle — All Colors

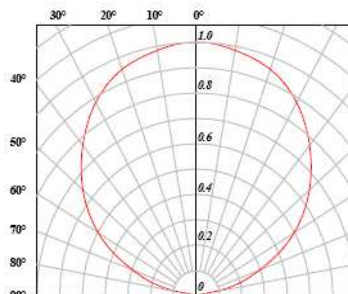

OPTEK reserves the right to make changes at any time in order to improve design and to supply the best product possible.

1-Watt SMD 6mm OVSPxBCR4 Series



Standard Bins ($I_F = 350\text{mA}$)

LEDs are sorted to the luminous flux (Φ) and the dominant wavelength (nm) bins shown. Each reel consists of a single intensity bin and a single color bin. Orders are filled utilizing all of the intensity bins or color bins listed in the following tables. Optek will not accept orders for single intensity bins or single color bins.

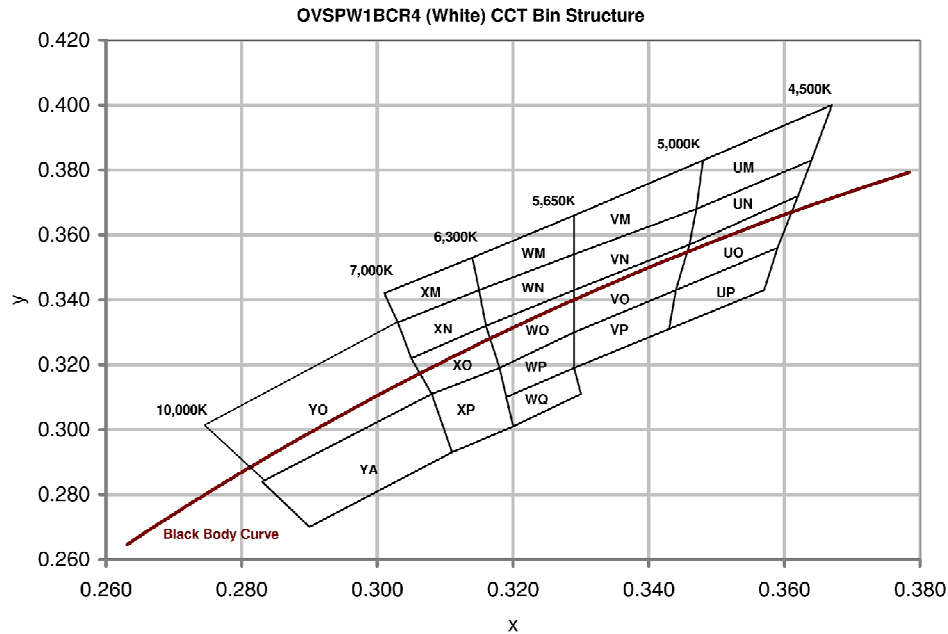

Φ	Luminous Flux (lm)	
	Bin	Max
T2	67	76
T3	76	87
U2	87	99
U3	99	113

Chromaticity Coordinates (x, y)

Rank	YO				YA															
Cx	0.274	0.303	0.308	0.283	0.283	0.308	0.311	0.290												
Cy	0.301	0.333	0.311	0.284	0.284	0.311	0.293	0.270												
Rank	XM				XN				XO				XP							
Cx	0.301	0.314	0.315	0.303	0.303	0.315	0.316	0.305	0.305	0.316	0.318	0.308	0.308	0.318	0.320	0.311				
Cy	0.342	0.353	0.343	0.333	0.333	0.343	0.332	0.322	0.322	0.332	0.319	0.311	0.311	0.319	0.301	0.293				
Rank	WM				WN				WO				WP				WQ			
Cx	0.314	0.329	0.329	0.315	0.315	0.329	0.329	0.316	0.316	0.329	0.329	0.318	0.318	0.329	0.329	0.319	0.319	0.329	0.330	0.320
Cy	0.353	0.366	0.354	0.343	0.343	0.354	0.343	0.332	0.332	0.343	0.330	0.319	0.319	0.330	0.319	0.310	0.310	0.319	0.311	0.301
Rank	VM				VN				VO				VP							
Cx	0.329	0.348	0.347	0.329	0.329	0.347	0.346	0.329	0.329	0.346	0.344	0.329	0.329	0.344	0.343	0.329				
Cy	0.366	0.383	0.368	0.354	0.354	0.368	0.357	0.343	0.343	0.357	0.343	0.330	0.330	0.343	0.331	0.319				
Rank	UM				UN				UO				UP							
Cx	0.348	0.367	0.364	0.347	0.347	0.364	0.362	0.346	0.346	0.362	0.359	0.344	0.344	0.359	0.357	0.343				
Cy	0.383	0.400	0.383	0.368	0.368	0.383	0.372	0.357	0.357	0.372	0.356	0.343	0.343	0.356	0.343	0.331				

OPTeK reserves the right to make changes at any time in order to improve design and to supply the best product possible.

Typical Electro-Optical Characteristics Curves—Red, Yellow

Relative Intensity Vs Forward Current

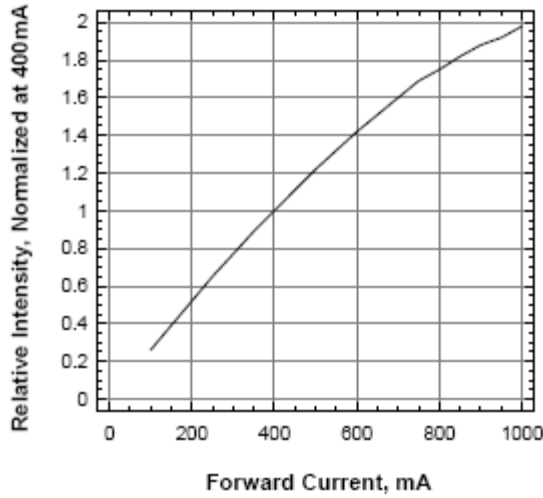

Forward Voltage Vs Forward Current

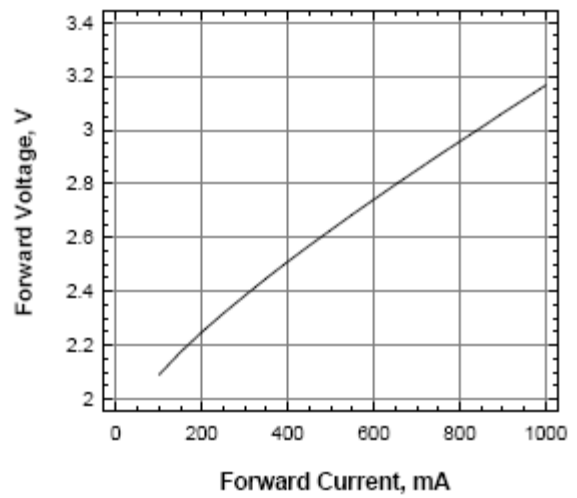

Maximum Current Vs Solder Point Temperature

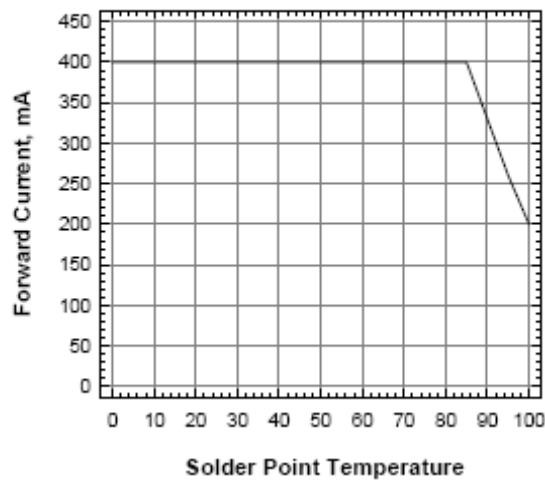

OPTEK reserves the right to make changes at any time in order to improve design and to supply the best product possible.

Typical Electro-Optical Characteristics Curves—Blue, Green

Wavelength Vs Forward Current

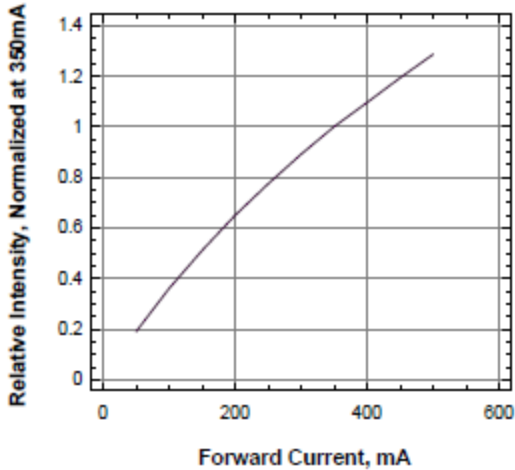

Relative Flux Vs Forward Current

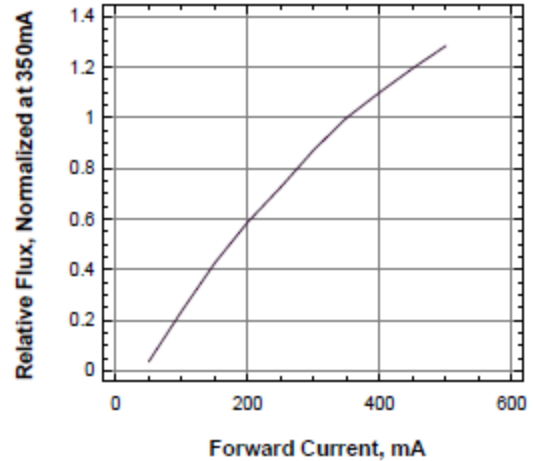

Forward Current Vs Forward Voltage

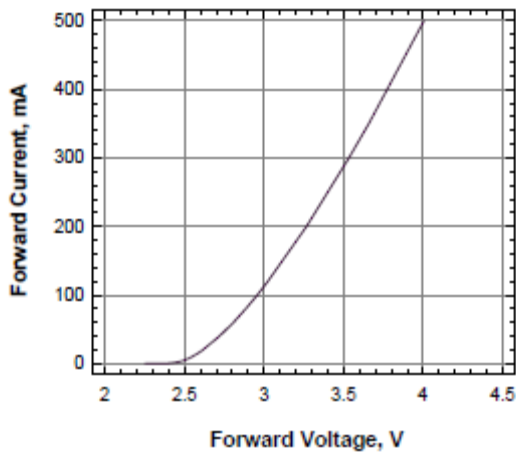

Forward Current Vs Ambient Temperature (Rja=40KW)

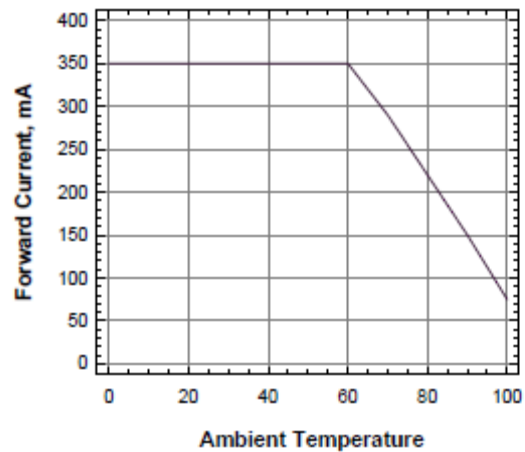

Forward Current Vs Solder Point Temperature

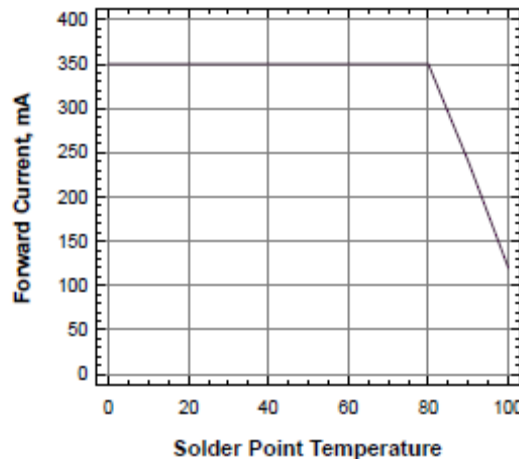

OPTEK reserves the right to make changes at any time in order to improve design and to supply the best product possible.

Typical Electro-Optical Characteristics Curves—White

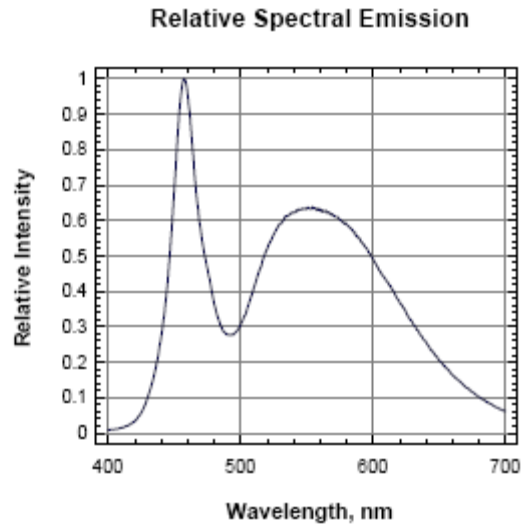
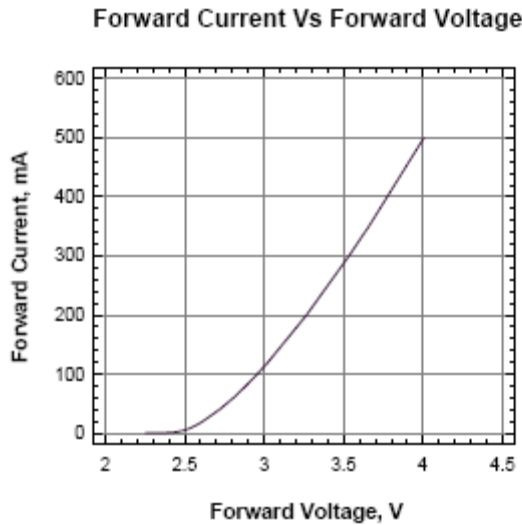
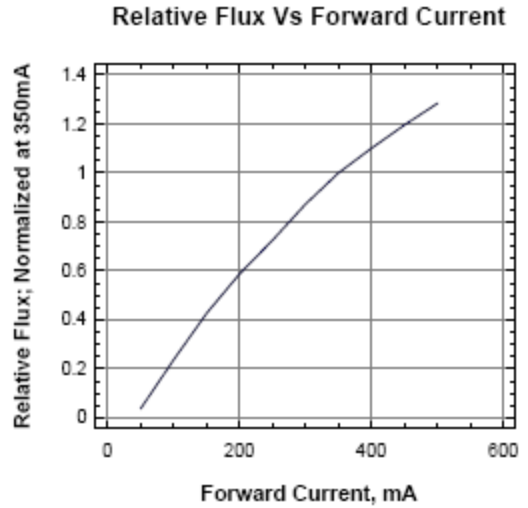
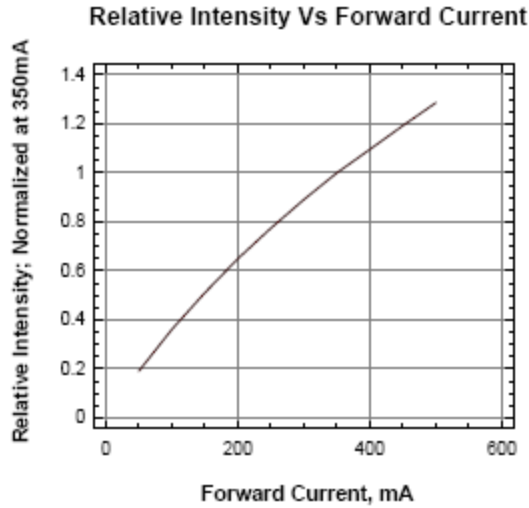

Forward Current Vs Ambient Temperature (R_{ja}=40K/W)

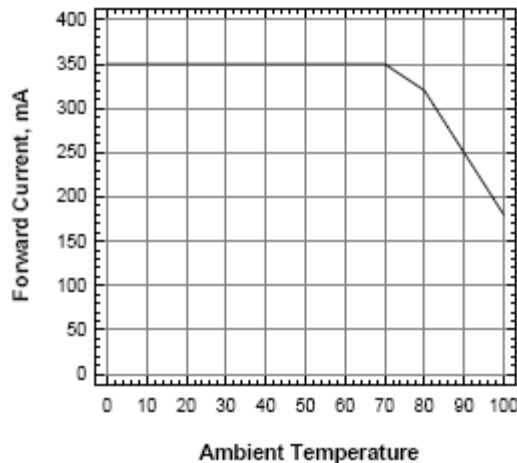

Forward Current Vs Solder Point Temperature

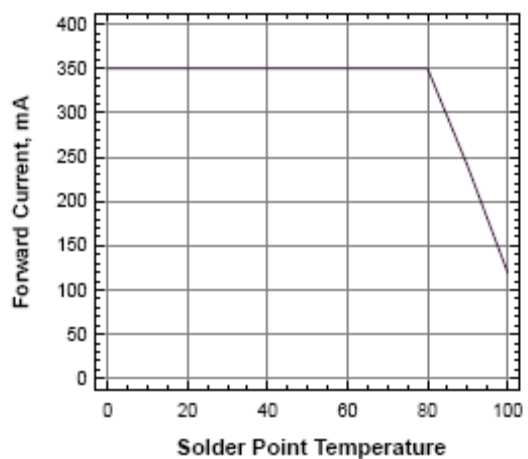

OPTEK reserves the right to make changes at any time in order to improve design and to supply the best product possible.

Solder Pad Design

Metal core circuit board (MCPCB) is highly recommended for high density applications.

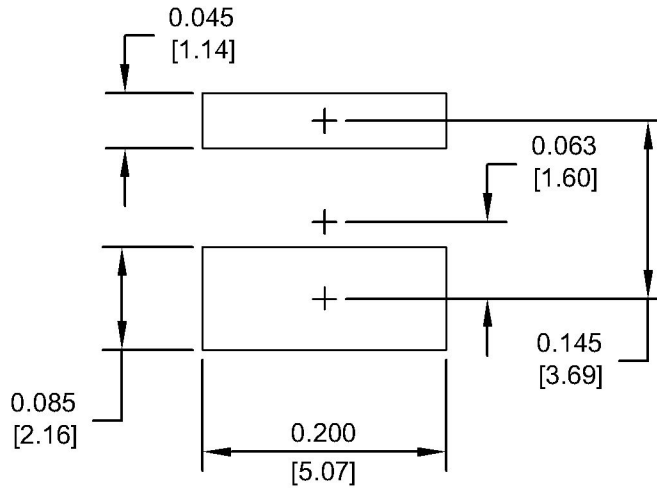

Solder Paste Pattern

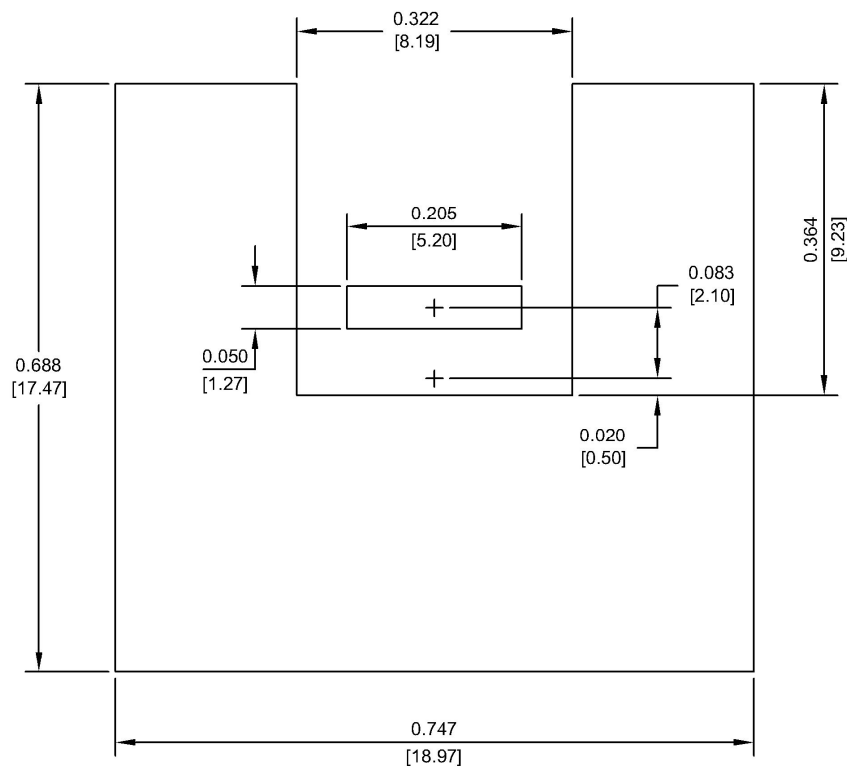

Copper Pattern

OPTEK reserves the right to make changes at any time in order to improve design and to supply the best product possible.

Recommended Sn-Pb IR-Reflow Soldering Profile.

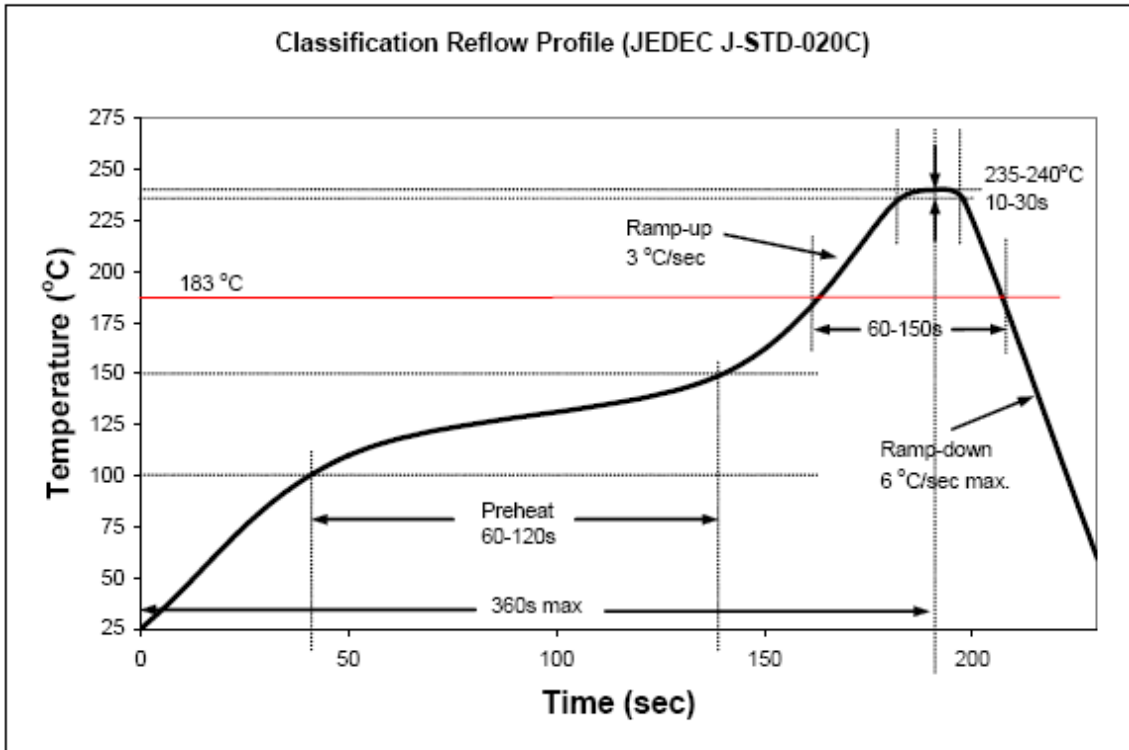

Recommended Pb Free IR-Reflow Soldering Profile.

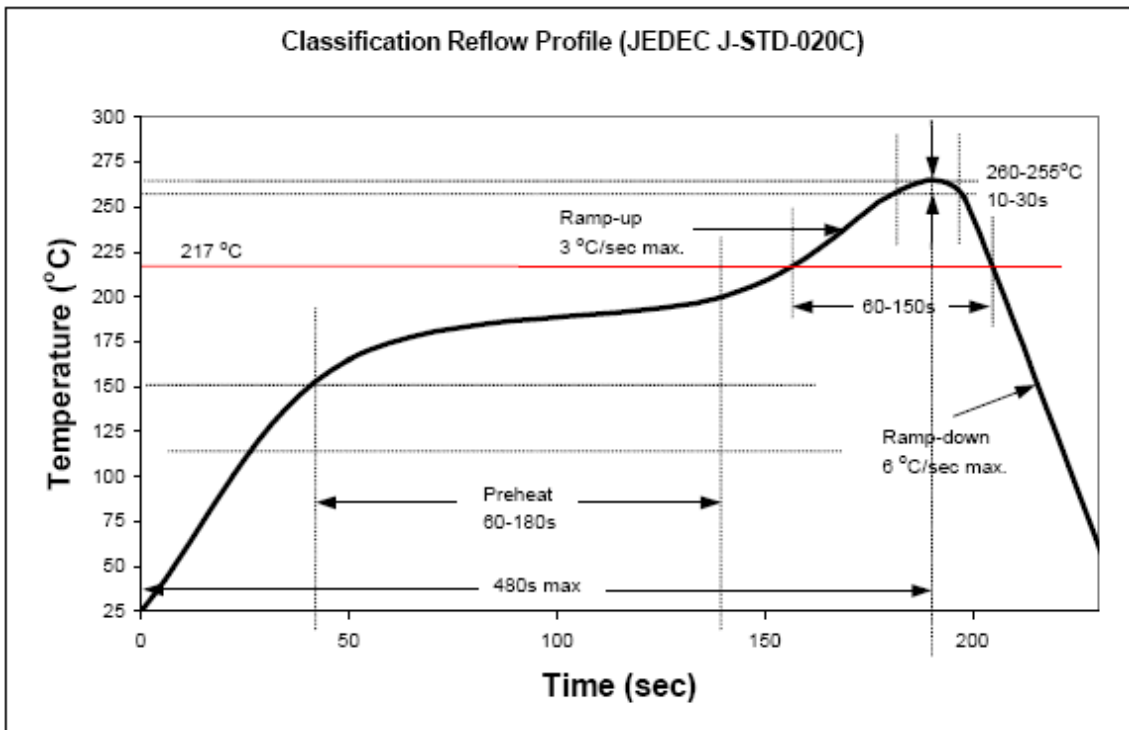

OPTEK reserves the right to make changes at any time in order to improve design and to supply the best product possible.

1-Watt SMD 6mm OVSPxBCR4 Series



Reel Dimensions: 13 - inch reel

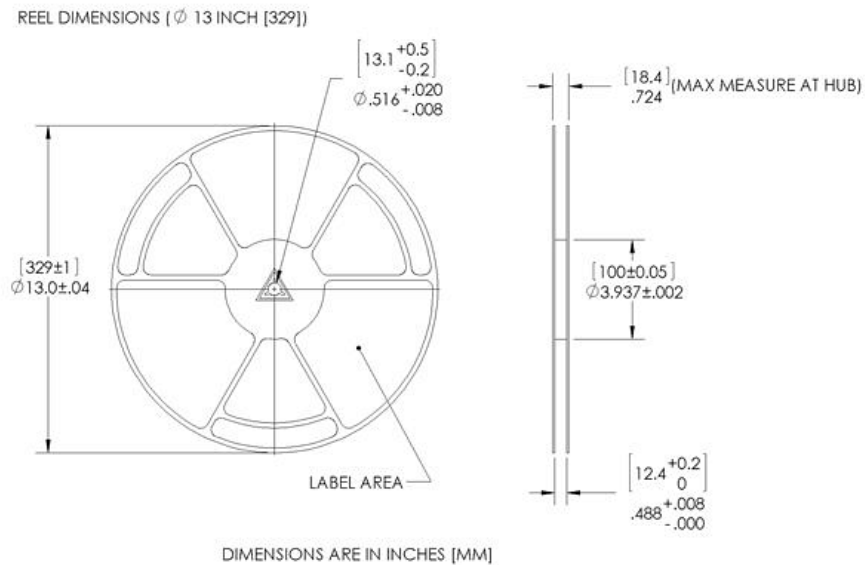

Carrier Tape Dimensions: Loaded quantity 2000 pieces per reel

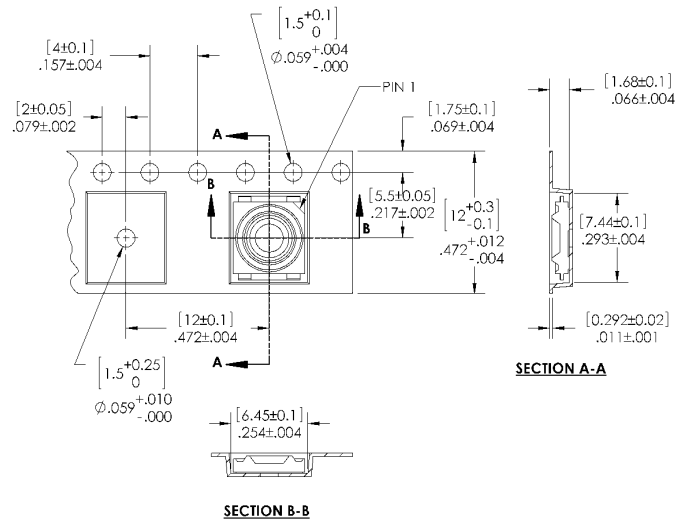

DIMENSIONS ARE IN INCHES [MM]
 TOLERANCES ARE $\pm .004$ [10] UNLESS OTHERWISE SPECIFIED

Moisture Resistant Packaging

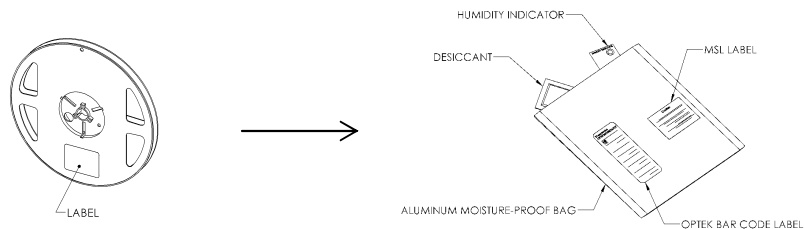

OPTEK reserves the right to make changes at any time in order to improve design and to supply the best product possible.