

G9EB-1

DC Power Relays (25-A Models)

DC Power Relays Capable of Interrupting High-voltage, High-current DC Load

- Utilizes a unique gas-filled, fully sealed, non-ceramic construction achieved by using resin with a metal case. This reduces the need for special processing and materials that were required with previous models, resulting in a low-cost relay that is both compact and lightweight.
- Smallest and lightest in its class at 25 × 60 × 58 mm and approximately 135 g. This is approximately half the volume and a third of the weight of other DC Power Relays in the same class (400 VDC, 25 A).*
- The unique design of the contact switching component and permanent magnet for blowing out the arc eliminates the need for polarity in the main circuit (contact terminal). This improves ease of wiring and installation, and contributes to providing failsafe measures against incorrect wiring.

* Based on our investigation as of December 2004.

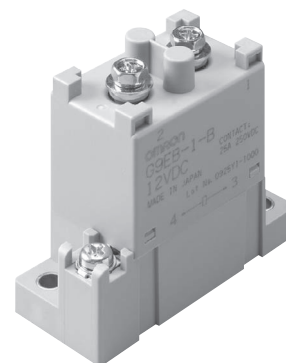

RoHS Compliant



Refer to "DC Power Relays Common Precautions".

Model Number Legend

G9EB-□-□-□-□
1 2 3 4

1. Number of Poles

1: 1 pole

3. Coil Terminals

B: M4 screw terminals

2. Contact Form

Blank: SPST-NO

4. Special Functions

List of Models

Models	Terminals		Contact form	Coil rated voltage	Model
	Coil terminals	Contact terminals			
Switching/current conduction models	Screw terminals	Screw terminals	SPST-NO	12 VDC 24 VDC 48 VDC 60 VDC 100 VDC	G9EB-1-B

Note 1. Two M4 screws are provided for the contact terminal connection.

Note 2. Two M4 screws are provided for the coil terminal connection.

Ratings

Coil

Rated voltage	Item	Rated current (mA)	Coil resistance (Ω)	Must-operate voltage (V)	Must-release voltage (V)	Maximum voltage (V)	Power consumption (W)
12 VDC		166.7	72	75% max. of rated voltage	10% min. of rated voltage	130% of rated volt-age (at 23°C within 10 minutes)	Approx. 2
24 VDC		83.3	288				
48 VDC		41.7	1,152				
60 VDC		33.3	1,800				
100 VDC		20	5,000				

Note 1. The figures for the rated current and coil resistance are for a coil temperature of 23°C and have a tolerance of ±10%.

Note 2. The figures for the operating characteristics are for a coil temperature of 23°C.

Note 3. The figure for the maximum voltage is the maximum voltage that can be applied to the relay coil.

Contacts

Item	Resistive load
	G9EB-1(-B)
Rated load	25 A at 250 VDC
Rated carry current	25 A
Maximum switching voltage	250 V
Maximum switching current	25 A

■ Characteristics

Item	Model	G9EB-1(-B)
Contact resistance *1		30 mΩ max.
Contact voltage drop		0.1 V max. (for a carry current of 25 A)
Operate time		30 ms max.
Release time		15 ms max.
Insulation resistance *2	Between coil and contacts	1,000 MΩ min.
	Between contacts of the same polarity	1,000 MΩ min.
Dielectric strength	Between coil and contacts	2,500 VAC, 1 min
	Between contacts of the same polarity	2,500 VAC, 1 min
Impulse withstand voltage *3		4,500 V
Vibration resistance	Destruction	10 to 55 to 10 Hz, 0.75-mm single amplitude (Acceleration: 2.94 to 88.9 m/s ²)
	Malfunction	10 to 55 to 10 Hz, 0.75-mm single amplitude (Acceleration: 2.94 to 88.9 m/s ²)
Shock resistance	Destruction	490 m/s ²
	Malfunction	100 m/s ²
Mechanical endurance *4		100,000 operations min.
Electrical endurance (resistive load) *5 *6		250 VDC, 25 A, 30,000 ops. min.
Short-time carry current		50 A (5 min), 40 A (10 min)
Maximum interruption current *6		100 A at 250 VDC (5 times)
Overload interruption *6		50 A at 250 VDC (50 times min.)
Ambient operating temperature		-40 to 70°C (with no icing or condensation)
Ambient operating humidity		5% to 85% RH
Weight (including accessories)		Approx. 135 g

Note. The above values are initial values at an ambient temperature of 23°C unless otherwise specified.

- *1. The contact resistance was measured with 1 A at 5 VDC using the voltage drop method.
- *2. The insulation resistance was measured with a 500-VDC megohmmeter.
- *3. The impulse withstand voltage was measured with a JEC-212 (1981) standard impulse voltage waveform (1.2 × 50 μs).
- *4. The mechanical endurance was measured at a switching frequency of 3,600 operations/hr.
- *5. The electrical endurance was measured at a switching frequency of 60 operations/hr.
- *6. These values are for when a varistor is used as the protective circuit against reverse surge in the relay coil.
Using a diode will reduce the switching characteristics.

Engineering Data

G9EB-1-B Switching/Current Conduction Models

● Maximum Switching Capacity

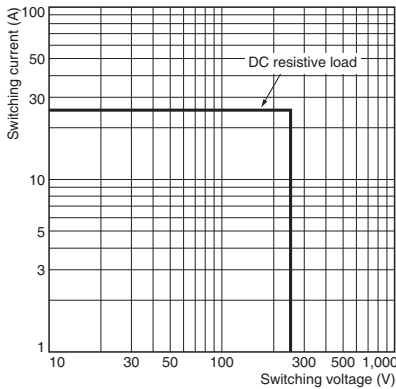

● Electrical Endurance (Switching Performance)

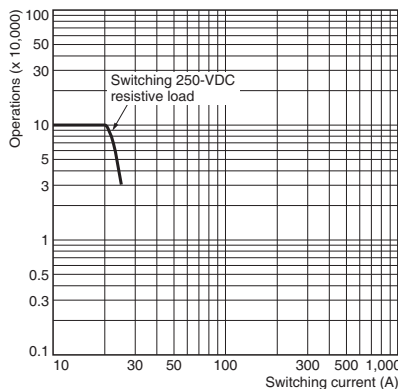

● Electrical Endurance (Interruption Performance)

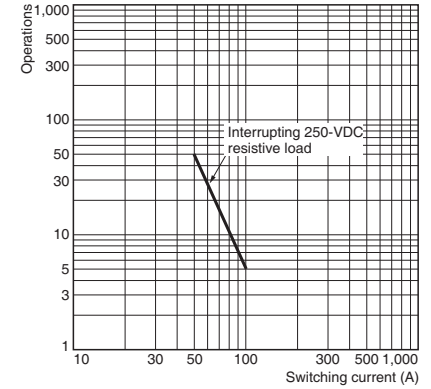

● Carry Current vs Energizing Time

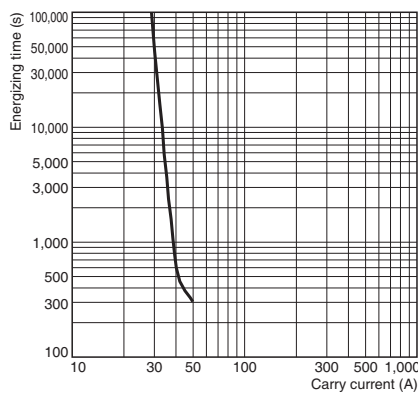

● Must-operate Voltage and Must-release Voltage Distributions

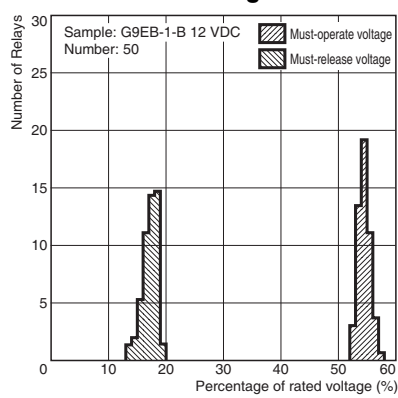

● Time Characteristic Distributions

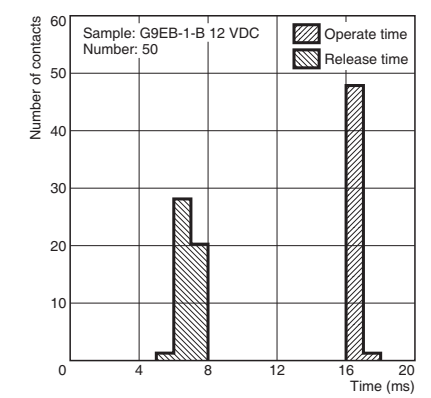

● Vibration Malfunction

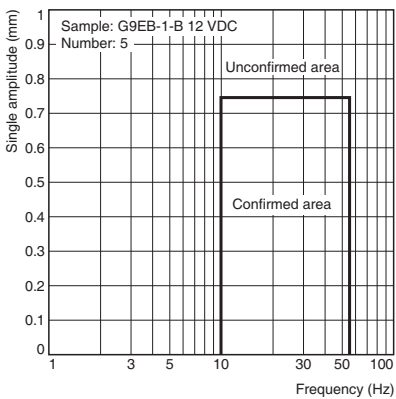

● Vibration Resistances

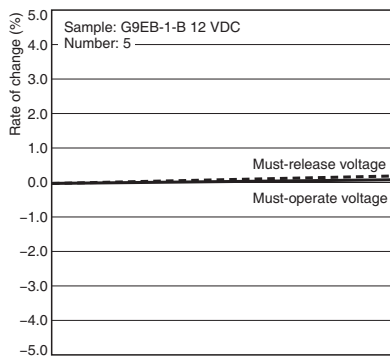

Start After test
Characteristics were measured after applying vibration at a frequency of 10 to 55 Hz (single amplitude of 0.75 mm) to the test piece (not energized) for 2 hours each in 3 directions. The percentage rate of change is the average value for all of the samples.

● Shock Malfunction

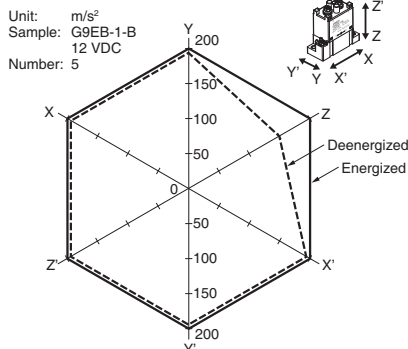

The value at which malfunction occurred was measured after applying shock to the test piece 3 times each in 6 directions along 3 axes.

● Shock Resistance

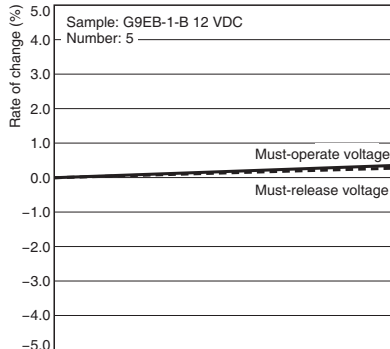

Start After test
Characteristics were measured after applying a shock of 490 m/s² to the test piece 3 times each in 6 directions along 3 axes. The percentage rate of change is the average value for all of the samples.

G9EB-1

■ Dimensions (Unit: mm)

● Screw Terminal Type G9EB-1-B

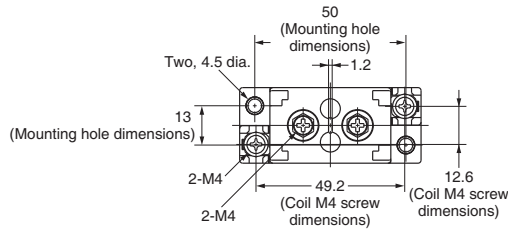
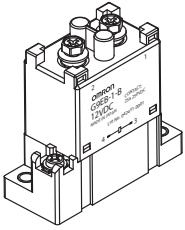

Terminal Arrangement/ Internal Connections (TOP VIEW)

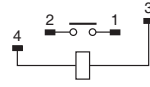

Mounting Hole Dimensions (TOP VIEW)

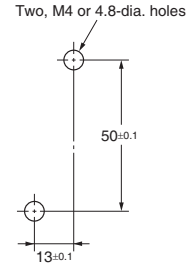

Dimension (mm)	Tolerance (mm)
10 or lower	±0.3
10 to 50	±0.5
50 or higher	±1

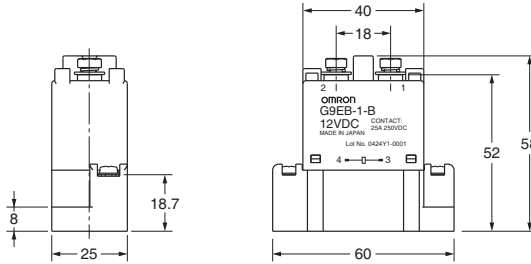

• Application examples provided in this document are for reference only. In actual applications, confirm equipment functions and safety before using the product.
 • Consult your OMRON representative before using the product under conditions which are not described in the manual or applying the product to nuclear control systems, railroad systems, aviation systems, vehicles, combustion systems, medical equipment, amusement machines, safety equipment, and other systems or equipment that may have a serious influence on lives and property if used improperly. Make sure that the ratings and performance characteristics of the product provide a margin of safety for the system or equipment, and be sure to provide the system or equipment with double safety mechanisms.

Note: Do not use this document to operate the Unit.